

Transportstrecke
Conveyor segment
Section de transport

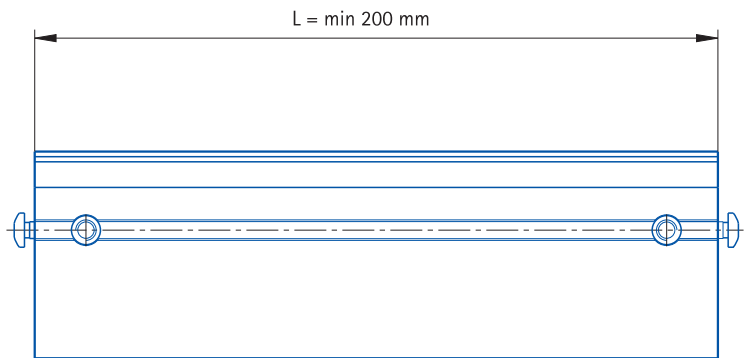
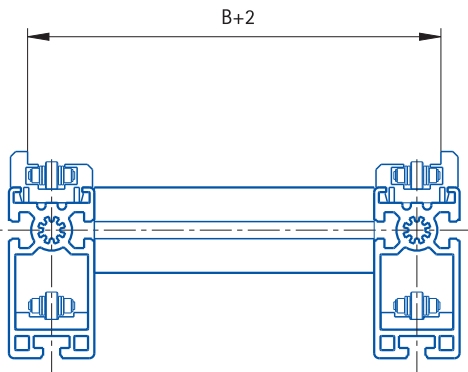

BS10
 Staurollenkette/
 Roller chain/
 Convoyeur
 d'accumulation
 à rouleaux
 1/2"

BS11
 Staurollenkette 1/2"/
 Roller chain 1/2"/
 Convoyeur
 d'accumulation
 à rouleaux 1/2"

BS20
 Gurtband/
 Belt/
 Convoyeur à
 courroies

BS30
 Zahnriemen/
 Toothed belt/
 Courroie dentée

BS50
 Duplexkette/
 Duplex chain/
 Convoyeur duplex
 3/8 x 7/32

BS60
 Scharnierbandkette*/
 Hinge chain*/
 Convoyeur à
 chaînes charnières*

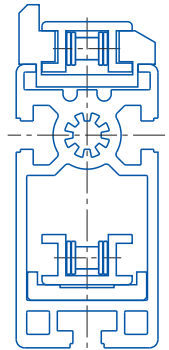
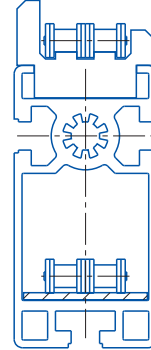
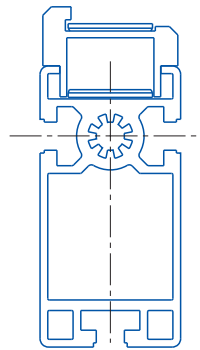
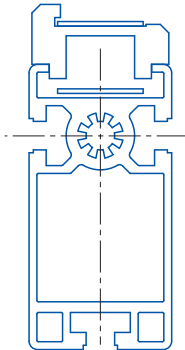
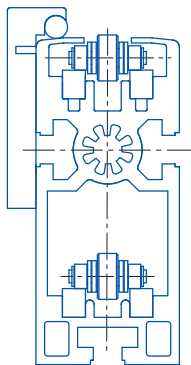
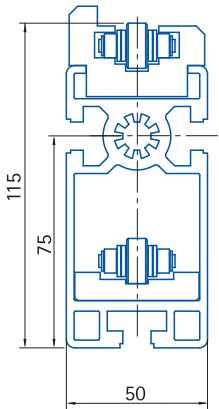

*mit Kunststoffauflage/
 *with plastic support/
 *avec supporte plastique

BS100
 Staurollenkette 3/4"/
 Roller chain 3/4"/
 Convoyeur d'accumulation
 à rouleaux 3/4"

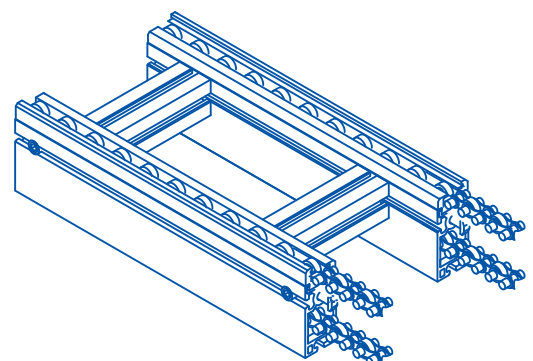
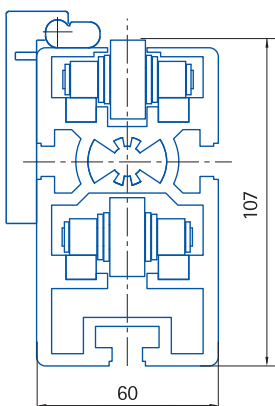

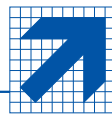

Bezeichnung Designation Désignation	Breite WT B Width pal. B Largeur de pal. B	Bestell-Nr. Ordering no. No. de commande		
Transportstrecke		BS10	BS11	BS20
Conveyor segment	160 mm	410 470 160 ... / L	411 470 160 ... / L	420 470 160 ... / L
Section de transport	240 mm	410 470 240 ... / L	411 470 240 ... / L	420 470 240 ... / L
	320 mm	410 470 320 ... / L	411 470 320 ... / L	420 470 320 ... / L
	400 mm	410 470 400 ... / L	411 470 400 ... / L	420 470 400 ... / L
	480 mm	410 470 480 ... / L	411 470 480 ... / L	420 470 480 ... / L
	560 mm	410 470 560 ... / L	411 470 560 ... / L	420 470 560 ... / L

Bezeichnung Designation Désignation	Breite WT B Width pal. B Largeur de pal. B	Bestell-Nr. Ordering no. No. de commande		
Transportstrecke		BS30	BS50	BS60
Conveyor segment	160 mm	430 470 160 ... / L	450 470 160 ... / L	460 470 160 ... / L
Section de transport	240 mm	430 470 240 ... / L	450 470 240 ... / L	460 470 240 ... / L
	320 mm	430 470 320 ... / L	450 470 320 ... / L	460 470 320 ... / L
	400 mm	430 470 400 ... / L	450 470 400 ... / L	460 470 400 ... / L
	480 mm	430 470 480 ... / L	450 470 480 ... / L	460 470 480 ... / L
	560 mm	430 470 560 ... / L	450 470 560 ... / L	460 470 560 ... / L

Bezeichnung Designation Désignation	Breite WT B Width pal. B Largeur de pal. B	Bestell-Nr. Ordering no. No. de commande	
Transportstrecke		BS100	
Conveyor segment	160 mm		
Section de transport	240 mm	490 470 240 ... / L	
	320 mm	490 470 320 ... / L	
	400 mm	490 470 400 ... / L	
	480 mm	490 470 480 ... / L	
	560 mm	490 470 560 ... / L	

Sonderausführungen nach Ihren individuellen Wünschen sind möglich.

Non-standard customized versions possible.

Des versions spéciales réalisées individuellement sur votre demande sont possibles.